



Specialist Access & Rescue Products Ltd.

User Guide Kestrel Full Body Harness



sar-products.com
+44 (0)161 621 0309
sales@sar-products.com

Conforms to
EN361:2002



Specialist Access & Rescue Products Ltd.

User Guide Kestrel Full Body Harness



sar-products.com
+44 (0)161 621 0309
sales@sar-products.com

Std:	QC:	
Serial No.:		

**UK
CA
0120 CE0598**

Product Record

This documentation should be issued with, and kept for, each item or system. Please see the product label for the details required below. Consult this guide for advice on inspection, maintenance, lifespan, etc.

Owner / User's Name:		Date of Purchase:	
Date of Manufacture:		Product Serial No.:	
Date of First Used:			

Inspection & Maintenance Record

Date & Time	Type of Inspection & Comments	Name & Signature of Inspector	Next Inspection Due

Declaration Of Conformity

The EU Declaration of conformity is available by scanning the QR code or visiting - www.sar-products.com/eu-doc/



Certificate Of Conformity

We certify that the Kestrel 2 conforms to the requirements set out in EN361:2002. The SAR Kestrel is rated to 150kg.

Signature:  For SAR Products Ltd

Specialist Access & Rescue Products Ltd.
Sarena House, Vulcan Street, Oldham, OL1 4LQ
+44 (0)161 621 0309 | sales@sar-products.com | www.sar-products.com

Front Sternal - (EN361)
Connection Point 'A/2'
Must always be used together,
in conjunction with a maillon.



2 Bar, 3 Bar
Adjustment buckles

2 Bar, 3 Bar or
QC Leg Buckles

Leg Loops

Rear Dorsal - (EN361)
Connection Point 'A'

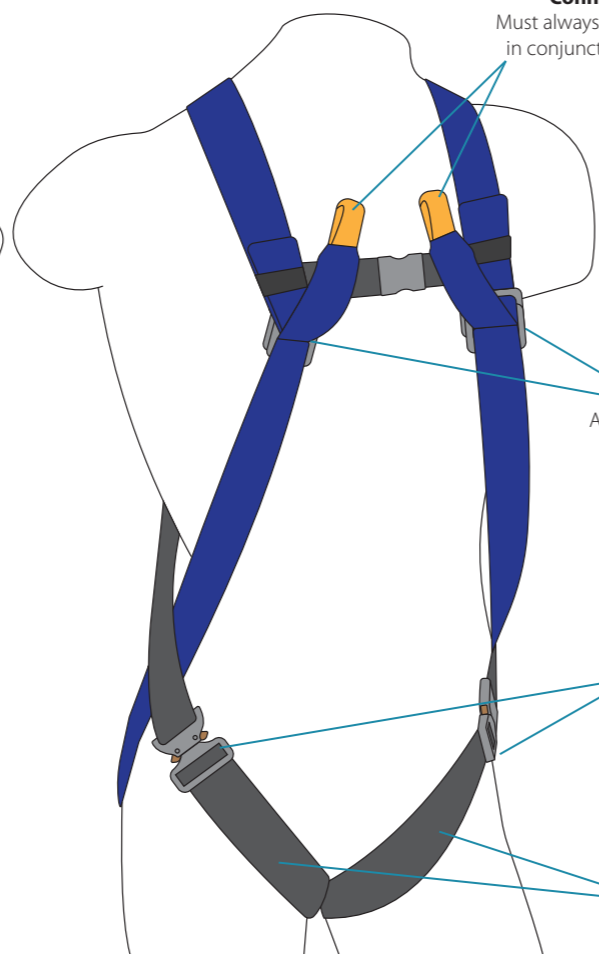
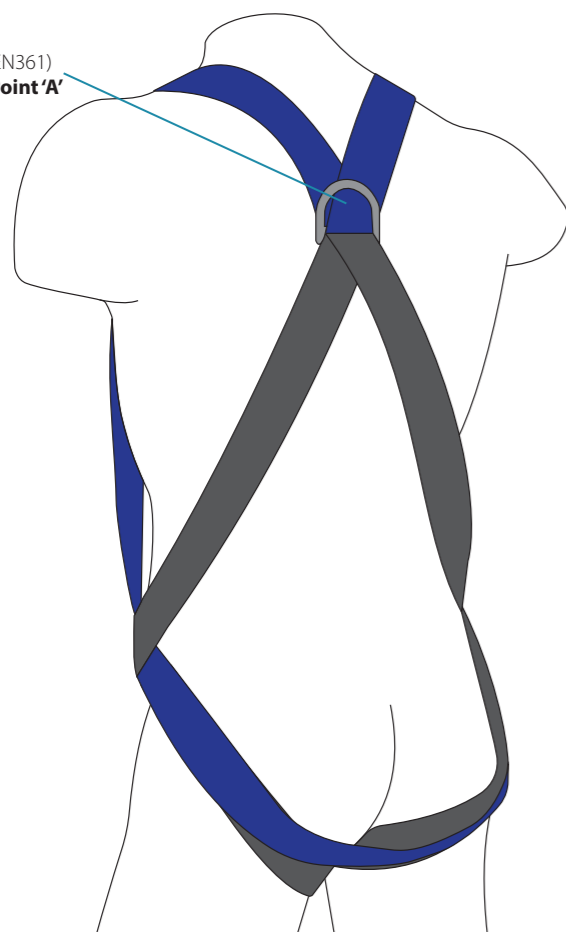

Kestrel Full Body Harness

Important

Please read and understand these instructions before use. This product should only be used by trained & competent operatives, or under the supervision of such a person.

Use

The Kestrel is a full body harness suitable for use in work at height/ fall arrest situations. The Kestrel features 2 fall arrest points (sternal & dorsal).

It is the user's responsibility to ensure that any items of PPE or other equipment used with the Kestrel are compatible and do not interfere with the safe function of any other component. Any item of equipment used must comply to the relevant standard(s).

Note: The information in this guide meets the requirements of the EU PPE Regulation 2016/425. It is not comprehensive and cannot be substituted for the correct training, which can be provided if required. If in any doubt, contact SAR Products using the supplied information.

Safety

The safety provided by the Kestrel Full Body Harness is dependant on the scenario, the anchors used and the skill of the user. The strength and suitability will be reduced through factors such as, but not limited to, age, wear & tear, abrasion, cuts, high impact loads, tight/sharp edges, knots, some chemicals (e.g. strong alkalis), UV exposure, environment (damp or icy conditions), failure to store & maintain as recommended, etc. An appropriate connection method must always be used between the harness and the anchor or system. The 2 front connection points must be joined together with a 8mm maillon when in use.

The user must consult the instructions for any other components used in a fall protection or fall arrest system and must pay attention to information including fall clearance distances, etc.

A rescue plan should always be in place prior to any work at height.

Do not alter or repair the product in any way.

Any component subjected to a dynamic loading should be examined and discarded if there is any sign of defect, or any doubts about its safety.

Lifespan

The lifespan of any product will be affected by the conditions in which it is used and stored/ maintained. This product is manufactured using high grade polyester webbing. Textile components should be retired no later than 10 years after the Date of Manufacture.

Metal components will have an indefinite lifespan, depending on use.

The working life will be reduced through general wear and tear, abrasion, cuts, damage to component parts, inappropriate ancillary equipment, high impact load, prolonged exposure to UV light including sunlight, elevated temperature (50° C max), exposure to some chemicals (e.g. strong alkalis) or failure to store and maintain as recommended. This list is not exhaustive.

Inspection

Before each use, conduct a visual inspection and function test to ensure the product is in serviceable condition and operates correctly. A periodic examination should be carried out at by a competent person at least every 12 months. These inspections should be recorded, paying particular attention to areas of potentially high wear such as attachment points, textiles, cams, bearings, etc. In the UK, the frequency of periodic inspection should be at least every 6 months; it is the user's responsibility to ensure they comply with the guidance for inspection in their own country or region.

Textiles: Check for cuts, tears & abrasions, damage due to deterioration, contact with heat, alkalis or other corrosives, label legibility.

Sewing: Check for broken, cut, loose or worn threads.

Metals: Check for cracks, distortion, corrosion, wear by abrasion, burrs, worn or loose rivets or screws, discolouration caused by extreme heat (greater than 100° C) broken springs, seizure of moving parts, broken or missing components, marking legibility.

Immediately withdraw from service any items showing defects. Any repairs must be carried out by the manufacturer or their authorised agent.

Anchorage

Anchor points should always be assessed for strength and suitability for the task (EN795, minimum 12kN). Sharp edges, abrasive or high temperature surfaces should be avoided or protected against.

Anchor points, wherever possible, should be above the user.

Cleaning

Rinse in clean cold water. If still soiled, wash in clean warm water (max. 40°C) with pure soap or a mild detergent (within pH range of 5.5 to 8.5). A machine wash may be used, but care must be taken to protect against mechanical damage, for example by placing the item in a bag prior to washing. Rinse thoroughly in clean cold water.

Chemicals

Avoid contact with any chemicals which could affect the performance of the product. If contact occurs, or is suspected, then remove the product from service immediately. If used in a marine environment, thoroughly rinse in clean cold water and dry after each use.

Storage

After cleaning, store unpacked in a cool, dry, dark place away from excessive heat sources or other possible causes of damage. Do not store wet.

Transport in a suitable protective bag.

If a long shelf life is required it is advisable to store in a moisture proof package.

Maintenance

Always keep the product clean and dry. Any excess moisture should be removed with a clean cloth and then allowed to dry naturally in a warm room away from direct heat. Metal parts may be lubricated with a dry PTFE lubricant or WD40 type spray. Excess lubricant should be wiped off to avoid attracting dirt.

Warning

Work at Height and Rescue are hazardous activities. It is the user's responsibility to ensure understanding of the correct and safe use of this equipment, to use it only for the purposes for which it is designed and to practise all proper safety procedures.

The time that a casualty is suspended should be kept to a minimum.

Attention should be paid to the dangers suspension trauma.

The user shall ensure that the safe function of this product is not impaired by, and does not impair, the safe function of another component or system.

The sternal and dorsal connection points (marked A) are suitable for fall arrest. Do not use the lower attachment points for fall arrest.

Markings

Each individual component is marked, where applicable, with:

- The name, trademark or any other means of identification provided by the manufacturer or supplier.
- The batch or serial number
- The date of manufacture (DoM)
- Product description and/or reference
- The British &/ or EN standard(s) to which the item conforms
- Waist size
- Load rating
- UKCA &/or CE mark with approved &/or notified body number

Strengths quoted are when the product is tested new and are in accordance with the manufacturer's test methods to the appropriate standard. Any weights and measurements are within the standard's specified tolerances.

Specification

Fully adjustable shoulders and legs

Choice of standard or Quick Clip (QC) buckles

Shaped padding on shoulders

User rating = 150kg (including tools & equipment)

Sizing

Standard - Waist: 74cm - 114cm
Legs: 42cm - 70cm

Extra Small - Waist: 64cm - 84cm
Legs: 32cm - 52cm

Extra Large - Waist: 104cm - 124cm
Legs: 60cm - 80cm

Approved Body UKCA

SGS United Kingdom Limited

Rossmore Business Park, Ellesmere Port, Cheshire, CH65 3EN

Approved Body No: 0120

Notified body

SGS FIMKO OY, Takomotie 8, FI-00380 Helsinki, Finland.

Notified body No: 0598

It is essential for the safety of the user that if the product is re-sold outside the original country of destination the reseller shall provide instructions for use, for maintenance, for periodic examination and for repair in the language of the country in which the product is to be used.

Nothing in this document affects the consumer's statutory rights.

Fitting Instructions

1. Unpack the harness and lay it out so that all buckles are undone and there are no twists in the webbing. (Fig 1)

2. Fit over the shoulders, allowing the harness to hang in position, again checking for twists. (Fig 2)

3. Fasten the plastic side release buckle at the chest. (Fig 3)

4. Reach between the legs, bring one of the leg straps through and fasten the buckle, following the appropriate buckle diagram. Repeat for the other leg strap. (Fig 4)

5. Tighten the shoulder and leg straps so that the fit is comfortable. (Fig 5)

6. Once fitted, check for any twists, that all buckles are fastened correctly, any excess webbing is secured back through the elastic ties, attachment points are positioned correctly, overall fit is snug but not over-tight or too loose. (Fig 6)

7. Finally, always ask another operative to conduct a buddy check to ensure all of the above is correct before committing to height. Buckles and fit should be regularly checked during use.

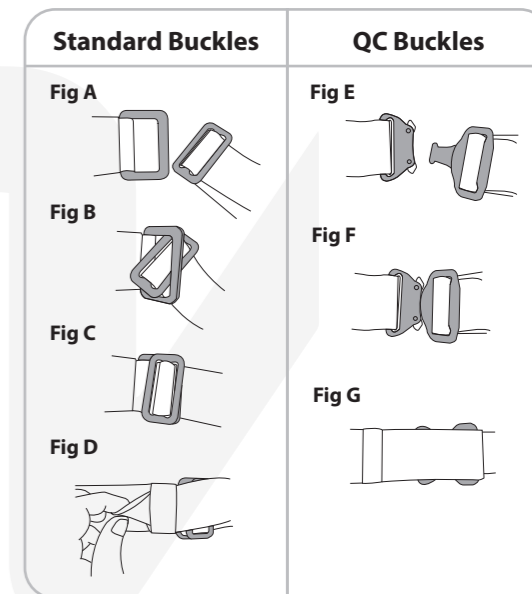

Fig 1

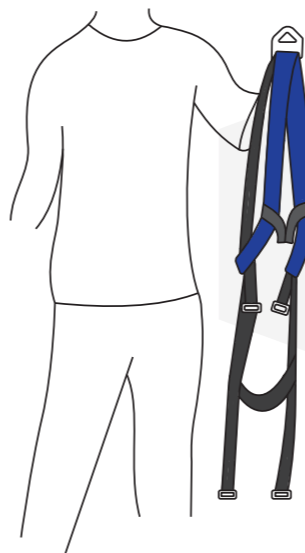

Fig 2



Fig 3

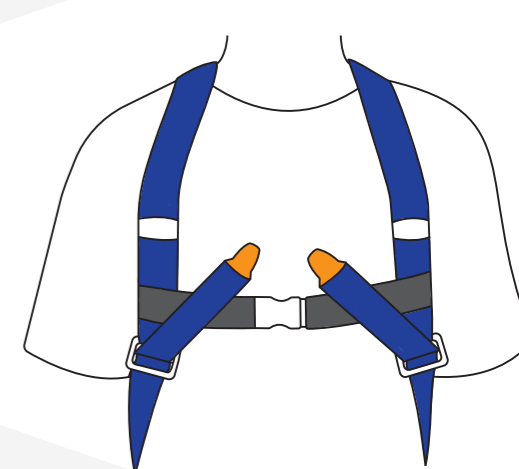

Fig 4

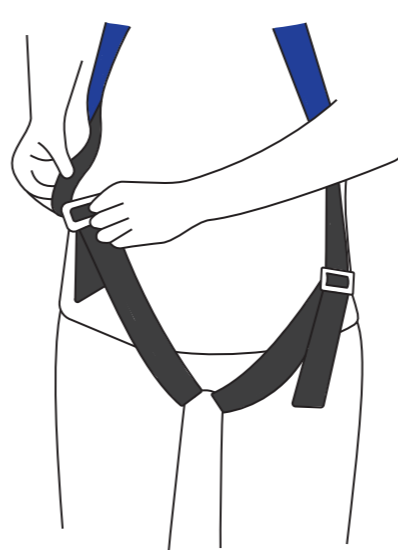

Fig 5

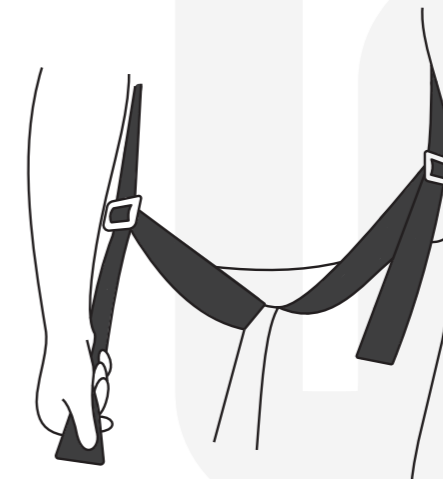

Fig 6

