

Product Record

This documentation should be issued with, and kept for, each item or system. Please see the product label for the details required below. Consult this guide for advice on inspection, maintenance, lifespan, etc.

Owner / User's Name:			
Date of Manufacture:		Date of Purchase:	
Date of First Used:		Product Serial No.:	

Inspection & Maintenance Record

Date & Time	Type of Inspection & Comments	Name & Signature of Inspector	Next Inspection Due

Declaration Of Conformity

The EU Declaration of conformity is available by scanning the QR code or visiting - www.sar-products.com/eu-doc/



Certificate Of Conformity

We certify that the Alpine MR Stretcher conforms to the EU Medical Devices Regulations 2017/745, Class 1 Medical Devices. Where applicable, individual components conform to the relevant EN standards - Connectors: EN362

SAR Alpine Stretchers have been approved for winching by the UK Maritime & Coastguard Agency, and also conform to the requirements of EASA/ CAA.

Signature:.......... For SAR Products Ltd

Specialist Access & Rescue Products Ltd.
Sarena House, Vulcan Street, Oldham, OL1 4LQ
+44 (0)161 621 0309 | sales@sar-products.com | www.sar-products.com



Specialist Access & Rescue
Products Ltd.

User Guide Alpine MR Stretcher



Info sticker

Barcode sticker

UK CA CE
Conforms to
EU MDR 2017/745

sar-products.com
+44 (0)161 621 0309
sales@sar-products.com

Alpine MR Stretcher

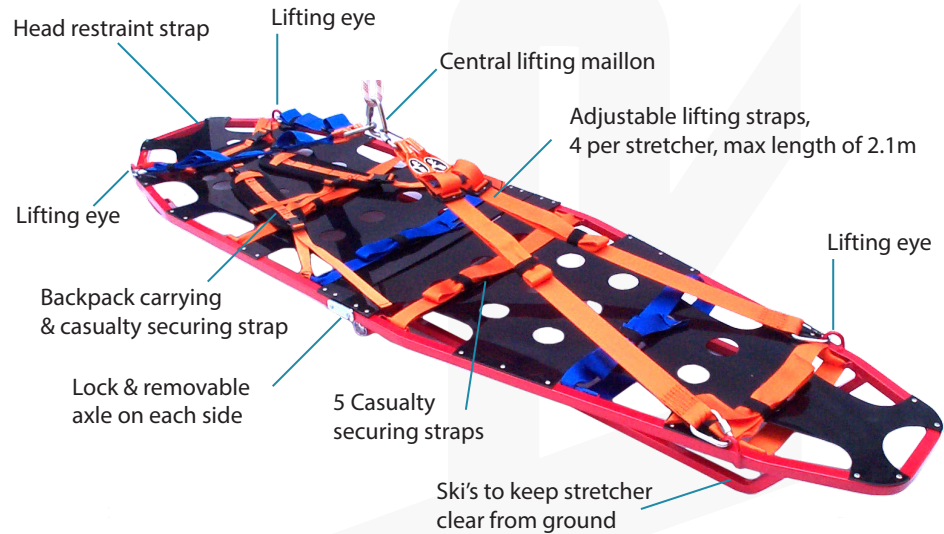

Use foot strap to secure stretcher in fold position



Hinge Lock



The stretcher can be split so it is easier to carry over long periods of time. To split stretcher remove central axle shaft pin while the stretcher is in a folded position, separate the stretcher halves, insert the pin back into the head end of the stretcher for carrying.

Central Axle Shaft Pin

Each half of the stretcher can then be fastened to a rescuers back pack.



Specifications:	
Stretcher including cas straps	13.4kg
Lifting slings (2.1m)	1.6kg
Length open	210cm
Length closed	105cm
Max width	60cm
Depth	12cm

Strengths:	
Horizontal lift (4 eyes)	40kN
Vertical lift (2 eyes)	20kN
Side pull on lifting eye (For info only- not recommended)	10kN
Casualty securing straps	20kN each
Safe Working Load	300kg
Safety factor (Assuming 100kg load)	≥20

Cleaning

Rinse in clean cold water. If still soiled, textiles may be washed in clean warm water (max. 40°C) with pure soap or a mild detergent (within pH range of 5.5 to 8.5). Rinse thoroughly in clean cold water. Metal and hard plastic components may be power washed with a low pressure setting.

Maintenance

Always keep the product clean and dry. Any excess moisture should be removed with a clean cloth and then allowed to dry naturally in a warm room away from direct heat.

Metal components may be lubricated with a dry PTFE lubricant or WD40 type spray. Excess lubricant should be wiped off to avoid attracting excess dirt.

Chemicals

Avoid contact with any chemicals which could affect the performance of the product. If contact occurs, or is suspected, then remove the product from service immediately.

If used in a marine environment, thoroughly rinse in clean cold water and dry after each use.

Storage

After cleaning, store unpacked in a cool, dry, dark place away from excessive heat sources or other possible causes of damage. Do not store wet.

Warning

Working at height and rescue are hazardous. It is the user's responsibility to ensure understanding of the correct and safe use of this equipment, to use it only for the purposes for which it is designed and to practise all proper safety procedures.

Markings

Each individual component is marked, where applicable, with:

- The name, trademark or any other means of identification provided by the manufacturer or supplier.
- The batch or serial number
- The date of manufacture (DoM)
- Product description and/or reference
- UKCA &/or CE mark

Strengths quoted are when the product is tested new and are in accordance with the manufacturer's test methods to the appropriate standard. Any weights and measurements are within the standard's specified tolerances.

Medical Devices are marked with the following further information:

- Conformance to MDR 2017/745, Class 1 Medical Devices
- Barcode which contains the UDI-DI, Date of Manufacture (YYMMDD format) and Serial Number

Nothing in this document affects the consumer's statutory rights.

Important:

Please read and understand these instructions before use. This product should only be used by trained & competent operatives.

Use

The Alpine Stretcher is designed for rescue- it is not Personal Protective Equipment (PPE). Each Alpine CR comes complete with casualty securing straps, adjustable lifting slings (for winching, lifting & lowering), and storage bag. The Stretcher must only be used in line with this user guide and with any instruction given by an authorised trainer, as well as ensuring any equipment is compatible.

Users should be trained & competent, or under the supervision of such a person.

Note: The information in this guide is not comprehensive and cannot be substituted for the correct training, which can be provided if required. If in any doubt, contact SAR Products using the supplied details.

Safety

The safety provided by the Alpine Stretcher is dependant on the scenario, the anchors used and the skill of the user. The strength and suitability will be reduced through factors such as, but not limited to, age, wear & tear, abrasion, cuts, high impact loads, tight/sharp edges, knots, some chemicals (e.g. strong alkalis), UV exposure, failure to store & maintain as recommended, etc. Do not alter the product in any way. Any component subjected to a dynamic loading should be examined and discarded if there is any sign of defect, or any doubts about its safety.

Lifespan

The maximum lifespan of a SAR Alpine Stretcher is 20 years from Date of Manufacture (DoM), subject to the following conditions:

- The stretcher should be subject to a regular, documented inspection regime, as well as pre- and post- use checks.
- After 10 years, the stretcher must be returned to the manufacturer, or their agent, for a full service, which will include replacement of textile components.
- After another 5 years (15 years total), the stretcher must be returned for an interim service.

The lifespan may be affected by other factors such as environmental influences, storage conditions, wear & tear, arduous events, misuse, etc. It is the user's responsibility to monitor the condition and suitability of the stretcher and to remove it from service if necessary.

Particular attention should be paid to textile components, especially lifting slings. These may be replaced independently if required. The maximum lifespan of textile components is 10 years from DoM.

Contact SAR Products for further information, using the supplied details.

Inspection

Before each use, conduct a visual inspection and function test to ensure the product is in serviceable condition and operates correctly. A thorough examination should be carried out at by a competent person least every 6 months. These inspections should be recorded, paying particular attention to areas of potentially high wear such as attachment points, textiles, cams, bearings, etc.

Textiles: Check for cuts, tears & abrasions, damage due to deterioration, contact with heat, alkalis or other corrosives.

Stitching: Check for broken, cut, loose or worn threads.

Metals: Check for cracks, distortion, corrosion, wear by abrasion, burrs, worn or loose rivets or screws, discolouration caused by extreme heat (greater than 100° C) broken springs, seizure of moving parts, broken or missing components.

Immediately withdraw from service any items showing defects. Any repairs must be carried out by the manufacturer or their authorised agent.

Anchorage

Anchor points should always be assessed for strength and suitability for the task. Sharp edges, abrasive or high temperature surfaces should be avoided or protected against.

Due to the potential for higher loads, the possibility of any fall should be eliminated during rescue activities.

The following diagrams and dimensions are provided as a guide only. Different techniques and scenarios may vary.

Horizontal Single Point

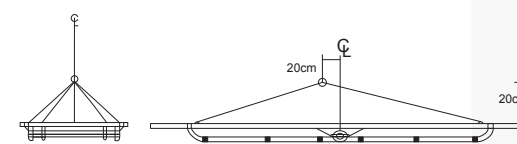

Horizontal Double Point

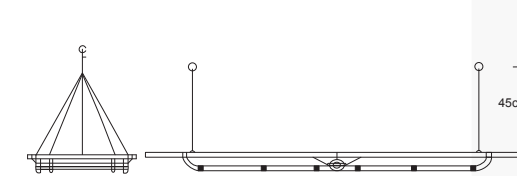

Vertical Lifting:

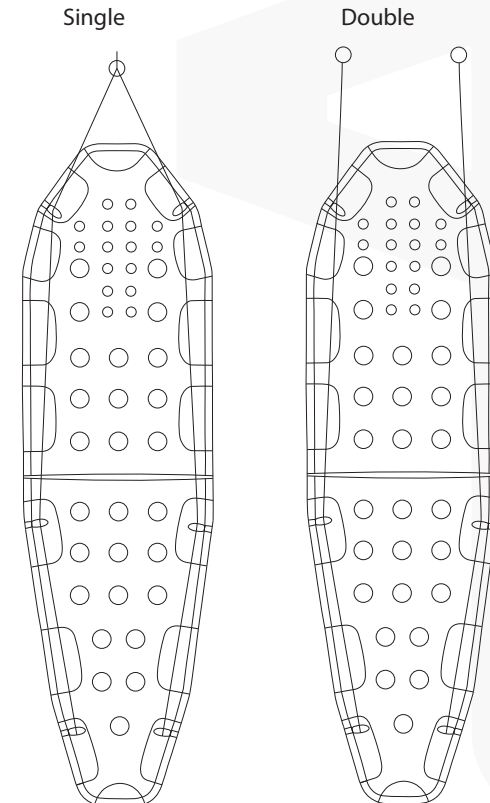

Typical vertical lift over sharp edge using double line system.

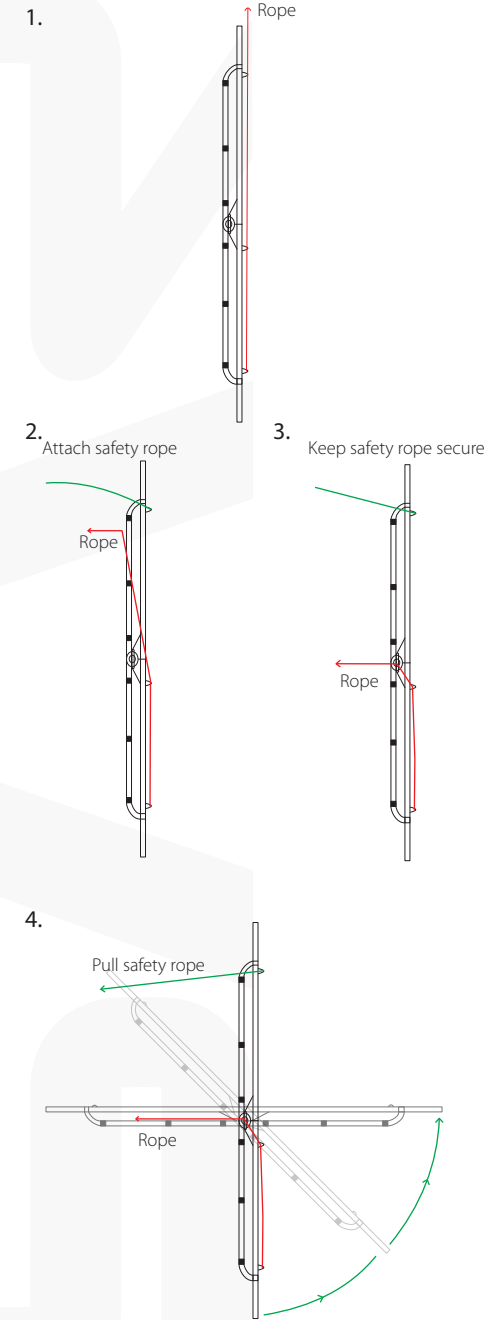

The stretcher comes without end carrying handles, these can be purchased separate for the Alpine CR. The illustrations below give some suggested carrying positions with and without handles.

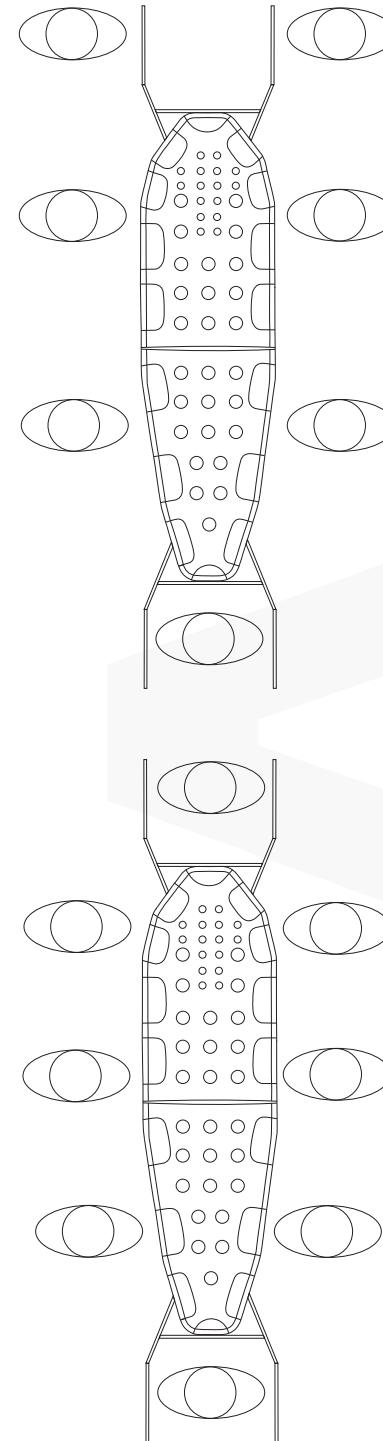
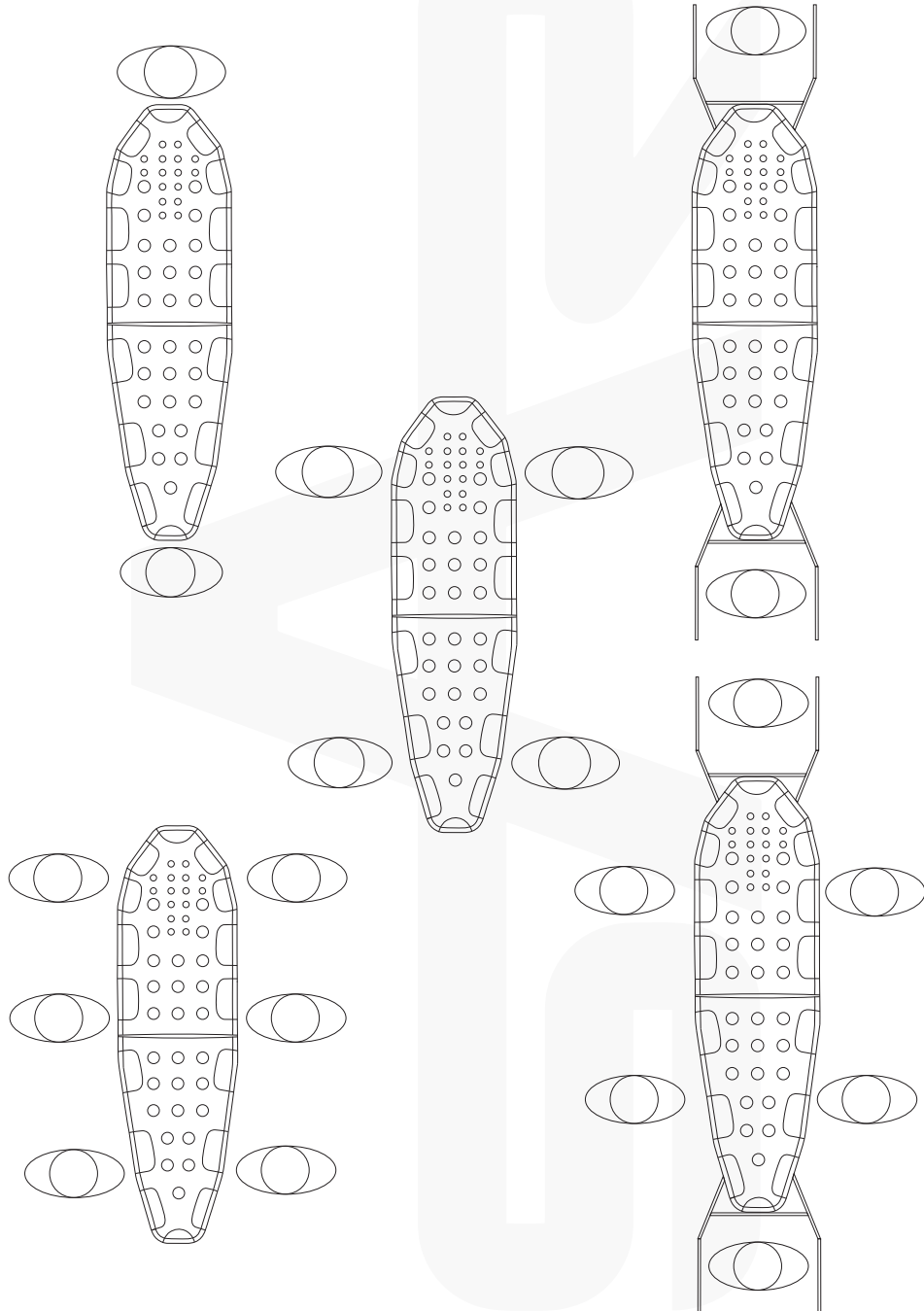

Accessories

The Alpine MR is supplied with a set of 4 lifting slings, a set of carrying handles, as well as a storage bag.

SAR can supply various accessories for the Alpine Stretcher:

- Carrying straps. Made from 44mm webbing, 2m long with a looped attachment end.
- Extensions for the casualty securing straps.
- A wheel which is fitted under the stretcher. This can be used to reduce the load on the carrying personnel, as well as making it easier to progress down narrow tracks.
- Replacement storage bag.
- Replacement lifting slings & connectors, casualty securing straps.

Contact SAR Products for further information, using the supplied details.

Product Record

This documentation should be issued with, and kept for, each item or system. Please see the product label for the details required below. Consult this guide for advice on inspection, maintenance, lifespan, etc.

Owner / User's Name:			
Date of Manufacture:		Date of Purchase:	
Date of First Used:		Product Serial No.:	

Inspection & Maintenance Record

Date & Time	Type of Inspection & Comments	Name & Signature of Inspector	Next Inspection Due

Declaration Of Conformity

The EU Declaration of conformity is available by scanning the QR code or visiting - www.sar-products.com/eu-doc/



Certificate Of Conformity

We certify that the Alpine CR Stretcher conforms to the EU Medical Devices Regulations 2017/745, Class 1 Medical Devices. Where applicable, individual components conform to the relevant EN standards - Connectors: EN362

SAR Alpine Stretchers have been approved for winching by the UK Maritime & Coastguard Agency, and also conform to the requirements of EASA/ CAA.

Signature:.......... For SAR Products Ltd

Specialist Access & Rescue Products Ltd.
Sarena House, Vulcan Street, Oldham, OL1 4LQ
+44 (0)161 621 0309 | sales@sar-products.com | www.sar-products.com



Specialist Access & Rescue
Products Ltd.

User Guide Alpine CR Stretcher

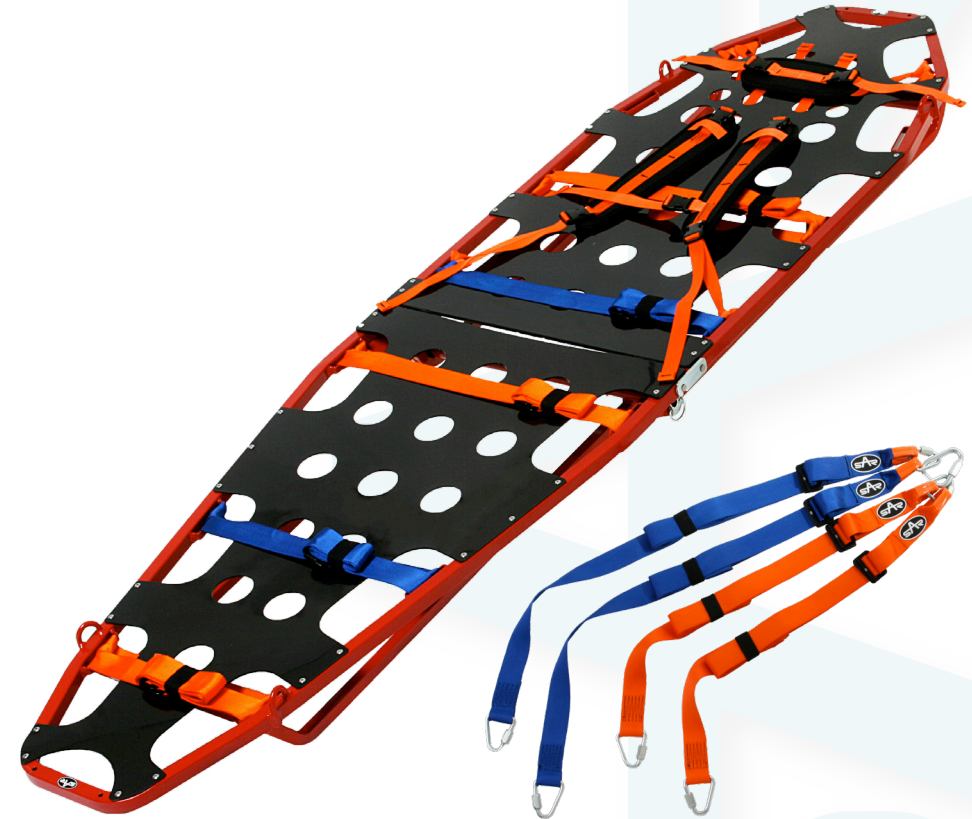

Info sticker

Barcode sticker

UK CA CE
Conforms to
EU MDR 2017/745

sar-products.com
+44 (0)161 621 0309
sales@sar-products.com

Alpine CR Stretcher

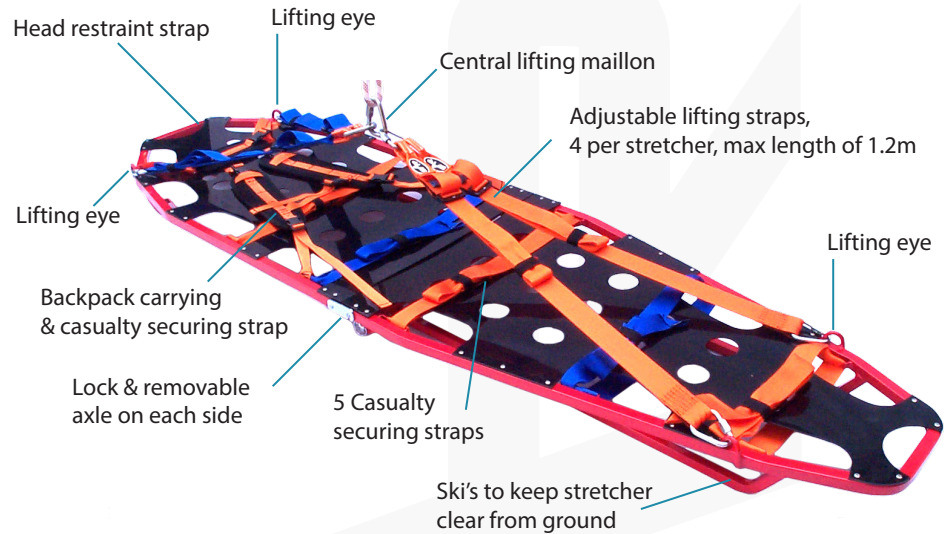

Use foot strap to secure stretcher in fold position



Hinge Lock



The stretcher can be split so it is easier to carry over long periods of time. To split stretcher remove central axle shaft pin while the stretcher is in a folded position, separate the stretcher halves, insert the pin back into the head end of the stretcher for carrying.

Central Axle Shaft Pin

Each half of the stretcher can then be fastened to a rescuers back pack.



Specifications:	
Stretcher including cas straps	13.4kg
Lifting slings (1.2m)	1.45kg
Length open	210cm
Length closed	105cm
Max width	60cm
Depth	12cm

Strengths:	
Horizontal lift (4 eyes)	40kN
Vertical lift (2 eyes)	20kN
Side pull on lifting eye (For info only- not recommended)	10kN
Casualty securing straps	20kN each
Safe Working Load	300kg
Safety factor (Assuming 100kg load)	≥20

Cleaning

Rinse in clean cold water. If still soiled, textiles may be washed in clean warm water (max. 40°C) with pure soap or a mild detergent (within pH range of 5.5 to 8.5). Rinse thoroughly in clean cold water. Metal and hard plastic components may be power washed with a low pressure setting.

Maintenance

Always keep the product clean and dry. Any excess moisture should be removed with a clean cloth and then allowed to dry naturally in a warm room away from direct heat.

Metal components may be lubricated with a dry PTFE lubricant or WD40 type spray. Excess lubricant should be wiped off to avoid attracting excess dirt.

Chemicals

Avoid contact with any chemicals which could affect the performance of the product. If contact occurs, or is suspected, then remove the product from service immediately.

If used in a marine environment, thoroughly rinse in clean cold water and dry after each use.

Storage

After cleaning, store unpacked in a cool, dry, dark place away from excessive heat sources or other possible causes of damage. Do not store wet.

Warning

Working at height and rescue are hazardous. It is the user's responsibility to ensure understanding of the correct and safe use of this equipment, to use it only for the purposes for which it is designed and to practise all proper safety procedures.

Markings

Each individual component is marked, where applicable, with:

- The name, trademark or any other means of identification provided by the manufacturer or supplier.
- The batch or serial number
- The date of manufacture (DoM)
- Product description and/or reference
- UKCA &/or CE mark

Strengths quoted are when the product is tested new and are in accordance with the manufacturer's test methods to the appropriate standard. Any weights and measurements are within the standard's specified tolerances.

Medical Devices are marked with the following further information:

- Conformance to MDR 2017/745, Class 1 Medical Devices
- Barcode which contains the UDI-DI, Date of Manufacture (YYMMDD format) and Serial Number

Nothing in this document affects the consumer's statutory rights.

Important:

Please read and understand these instructions before use. This product should only be used by trained & competent operatives.

Use

The Alpine Stretcher is designed for rescue- it is not Personal Protective Equipment (PPE). Each Alpine CR comes complete with casualty securing straps, adjustable lifting slings (for winching, lifting & lowering), and storage bag. The Stretcher must be only be used in line with this user guide and with any instruction given by an authorised trainer, as well as ensuring any equipment is compatible.

Users should be trained & competent, or under the supervision of such a person.

Note: The information in this guide is not comprehensive and cannot be substituted for the correct training, which can be provided if required. If in any doubt, contact SAR Products using the supplied details.

Safety

The safety provided by the Alpine Stretcher is dependant on the scenario, the anchors used and the skill of the user. The strength and suitability will be reduced through factors such as, but not limited to, age, wear & tear, abrasion, cuts, high impact loads, tight/sharp edges, knots, some chemicals (e.g. strong alkalis), UV exposure, failure to store & maintain as recommended, etc. Do not alter the product in any way. Any component subjected to a dynamic loading should be examined and discarded if there is any sign of defect, or any doubts about its safety.

Lifespan

The maximum lifespan of a SAR Alpine Stretcher is 20 years from Date of Manufacture (DoM), subject to the following conditions:

- The stretcher should be subject to a regular, documented inspection regime, as well as pre- and post- use checks.
- After 10 years, the stretcher must be returned to the manufacturer, or their agent, for a full service, which will include replacement of textile components.
- After another 5 years (15 years total), the stretcher must be returned for an interim service.

The lifespan may be affected by other factors such as environmental influences, storage conditions, wear & tear, arduous events, misuse, etc. It is the user's responsibility to monitor the condition and suitability of the stretcher and to remove it from service if necessary.

Particular attention should be paid to textile components, especially lifting slings. These may be replaced independently if required. The maximum lifespan of textile components is 10 years from DoM.

Contact SAR Products for further information, using the supplied details.

Inspection

Before each use, conduct a visual inspection and function test to ensure the product is in serviceable condition and operates correctly. A thorough examination should be carried out at by a competent person least every 6 months. These inspections should be recorded, paying particular attention to areas of potentially high wear such as attachment points, textiles, cams, bearings, etc.

Textiles: Check for cuts, tears & abrasions, damage due to deterioration, contact with heat, alkalis or other corrosives.

Stitching: Check for broken, cut, loose or worn threads.

Metals: Check for cracks, distortion, corrosion, wear by abrasion, burrs, worn or loose rivets or screws, discolouration caused by extreme heat (greater than 100° C) broken springs, seizure of moving parts, broken or missing components.

Immediately withdraw from service any items showing defects. Any repairs must be carried out by the manufacturer or their authorised agent.

Anchorage

Anchor points should always be assessed for strength and suitability for the task. Sharp edges, abrasive or high temperature surfaces should be avoided or protected against.

Due to the potential for higher loads, the possibility of any fall should be eliminated during rescue activities.

The following diagrams and dimensions are provided as a guide only. Different techniques and scenarios may vary.

Horizontal Single Point

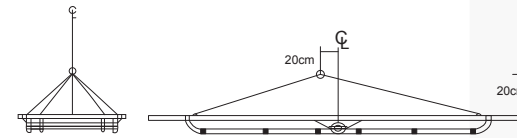

Horizontal Double Point

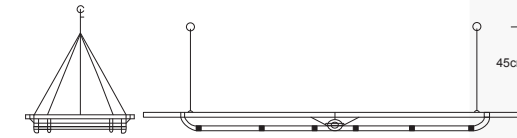

Vertical Lifting:

Single

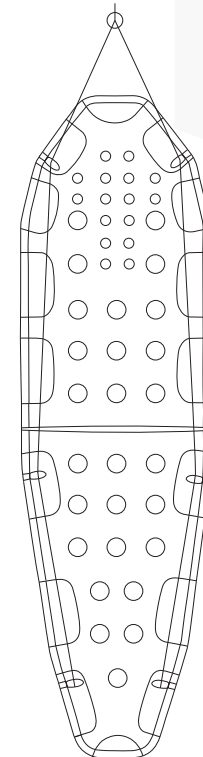

Double

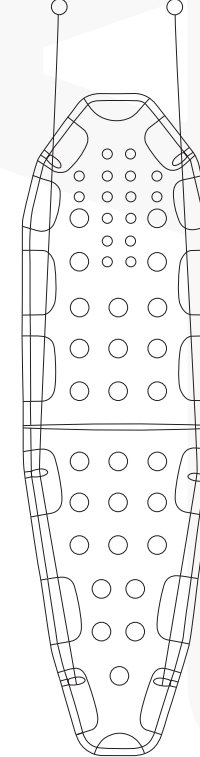

Typical vertical lift over sharp edge using double line system.

1.

Rope



2.

Attach safety rope

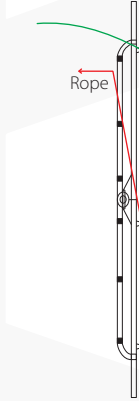

3.

Keep safety rope secure

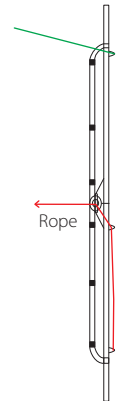

4.

Pull safety rope

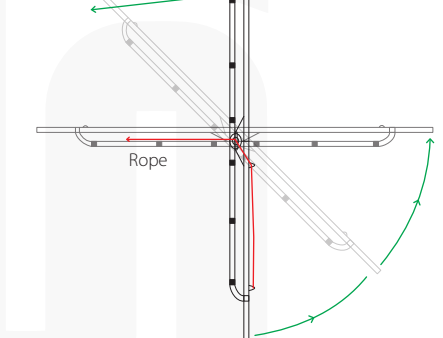

The stretcher comes without end carrying handles, these can be purchased separate for the Alpine CR. The illustrations below give some suggested carrying positions with and without handles.

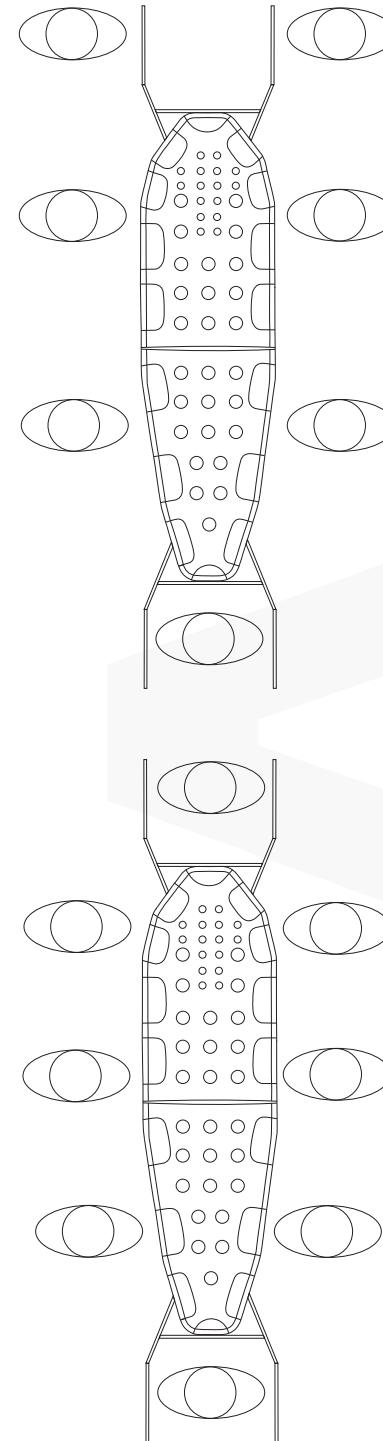
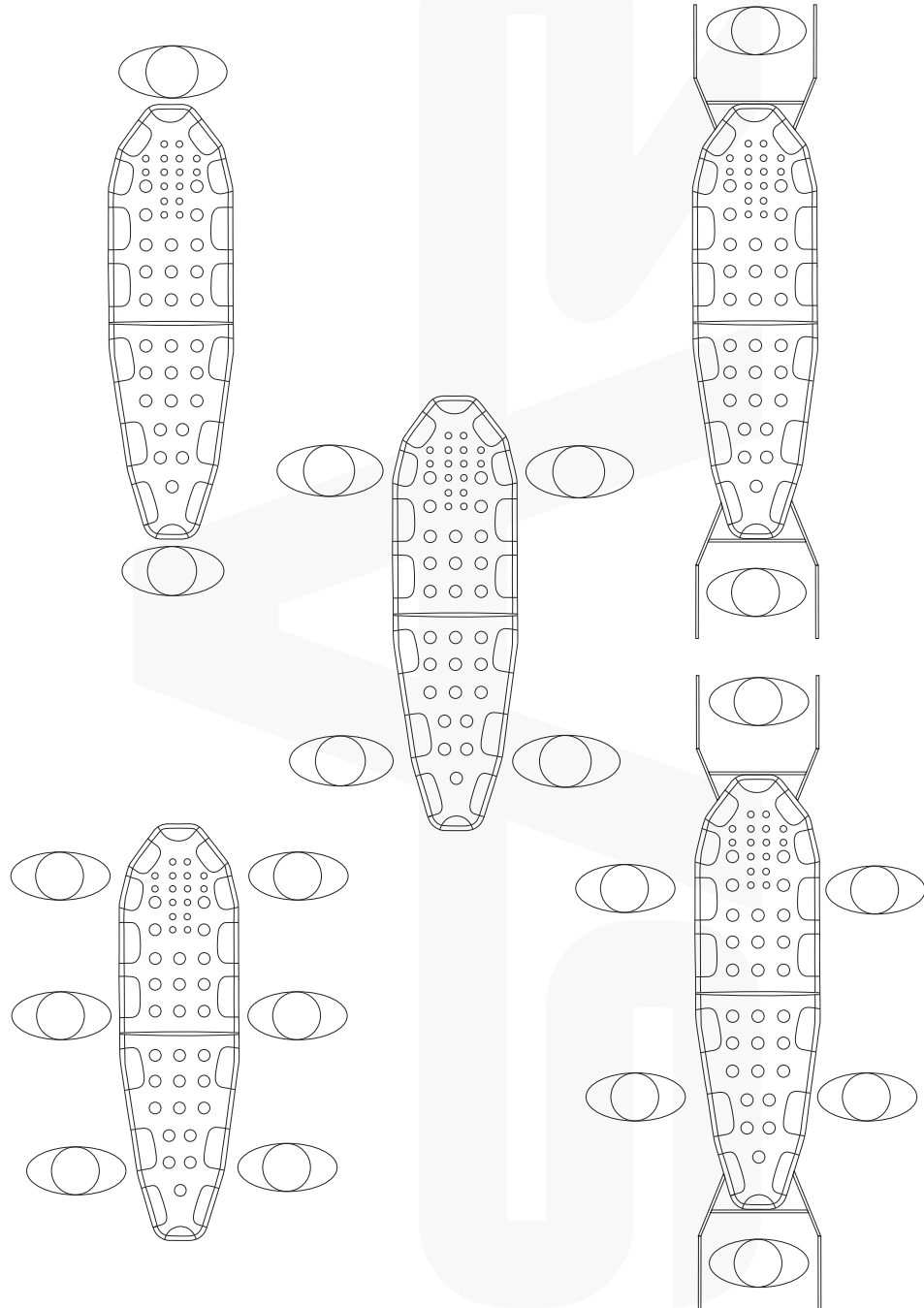

Accessories

The Alpine CR is supplied with a set of 4 lifting slings, as well as a storage bag.

SAR can supply various accessories for the Alpine Stretcher:

- Carrying straps. Made from 44mm webbing, 2m long with a looped attachment end.
- Extensions for the casualty securing straps.
- Carrying handles for fitting to the ends of the stretcher.
- A wheel which is fitted under the stretcher. This can be used to reduce the load on the carrying personnel, as well as making it easier to progress down narrow tracks.
- Replacement storage bag.
- Replacement lifting slings & connectors, casualty securing straps.

Contact SAR Products for further information, using the supplied details.